



**ND 1000 S
Operating Instructions**

June 1997

Meret Optical Communications, Inc.



| Index | Page |
|---|---------|
| 1 Introduction | I / 1 |
| 2 Installation | II / 1 |
| 2.1 Unpacking | II / 1 |
| 2.2 Setting up the ND 1000 S | II / 1 |
| 2.3 Mains Voltage | II / 2 |
| 2.4 Replacing a Fuse / Adjusting the Mains Voltage | II / 2 |
| 2.4.1 Replacing a Fuse | II / 3 |
| 2.4.2 Setting the Mains Voltage | II / 4 |
| 3 Construction of the ND 1000 S | III / 1 |
| 3.1 Front Panel | III / 1 |
| 3.2 Rear Panel | III / 2 |
| 4 Connections of the ND 1000 S | IV / 1 |
| 4.1 N-Connector of ND 1000 S | IV / 1 |
| 4.2 10 MHz Reference Input | IV / 1 |
| 4.3 10 MHz Reference Output | IV / 2 |
| 5 Operation of the Frequency Synthesizer ND 1000 S | V / 1 |
| 5.1 Interface switch in position BCD-REMOTE: | V / 1 |
| 5.2 Interface switch in position IEEE / RS232: | V / 1 |
| 5.2.1 Setting of IEEE-listener address | V / 1 |
| 5.2.2 RS 232-Interface | V / 2 |
| 5.3 Setting Frequency and Signal Output Level..... | V / 2 |
| 5.3.1 Setting Frequency via Rotary Switches..... | V / 2 |
| 5.3.2 Power level setting | V / 4 |



| | | |
|----------|--|---------|
| 6 | Interfaces | VI / 1 |
| 6.1 | BCD Interface..... | VI / 1 |
| 6.1.1 | BCD modes | VI / 1 |
| 6.1.2 | Pin Assignment of the BCD Interface mode 1: positive logic with store | VI / 2 |
| 6.1.3 | Pin Assignment of the BCD Interface mode 2 and 3 Mode 2 positive logic transparentMode 3 negative logic transparent | VI / 3 |
| 6.1.4 | Pin Assignment of the BCD Interface mode 4latch enable and remote enable..... | VI / 4 |
| 6.1.5 | Pin Assignment of the BCD Interface mode 5double buffering, negative logic with store and remote enable | VI / 6 |
| 6.2 | RS 232 Interface | VI / 8 |
| 6.2.1 | Definition of the RS 232 interface | VI / 8 |
| 6.2.2 | Pin Configuration of the RS 232 Interface..... | VI / 8 |
| 6.2.3 | Connecting the ND 1000 S to Personal Computer..... | VI / 9 |
| 6.2.4 | Programming of the RS 232 Interface..... | VI / 9 |
| 6.2.4.1 | Composition of a data block..... | VI / 9 |
| 6.2.4.2 | Structure of RS 232 command PC → ND 1000 S..... | VI / 10 |
| 6.2.4.3 | Structure of RS 232 message (echo) ND 1000 S → PC..... | VI / 10 |
| 6.2.5 | Local / Remote mode of the ND 1000 S..... | VI / 10 |
| 6.2.6 | Instrument message for ND 1000 S | VI / 11 |
| 6.3 | IEEE 488 Interface | VI / 12 |
| 6.3.1 | Description of the IEEE 488 Interface | VI / 13 |
| 6.3.1.1 | Data Bus | VI / 13 |
| 6.3.1.2 | Control Bus | VI / 13 |
| 6.3.1.3 | Handshake Bus..... | VI / 14 |
| 6.3.2 | Structure of the IEEE 488 interface..... | VI / 14 |
| 6.3.3 | Local / Remote mode of the ND 1000 S..... | VI / 14 |
| 6.3.4 | Setting of the IEEE-listener address on the ND 1000 S..... | VI / 15 |
| 6.3.5 | Interface Messages | VI / 15 |
| 6.3.5.1 | Universal Instructions..... | VI / 16 |
| 6.3.5.2 | Addressed Instructions..... | VI / 16 |
| 6.3.6 | Instrument Messages | VI / 17 |
| 6.3.6.1 | Structure of an instrument message | VI / 17 |
| 6.3.6.2 | Instrument messages for the ND 1000 S | VI / 17 |
| 7 | Appendix | VII / 1 |
| 7.1 | Technical Specifications ND 1000 S | VII / 1 |
| 7.2 | Service: Reference frequency calibration..... | VII / 2 |
| 7.3 | Ordering Specifications ND 1000 Series..... | VII / 2 |



1 Introduction

The frequency synthesizer ND 1000 S is a direct synthesizer RF-generator. The output frequency is set in exactly decade-related steps with 0.1Hz resolution (0.2 Hz \geq 500 MHz). The accuracy of the output frequency is solely determined by the frequency reference.

Combining conventional RF-modules for greater frequency steps with a DDS (**D**irect **D**igital **S**ynthesizer) for smaller frequency steps makes possible excellent technical data for residual FM, high spectral purity and very fast frequency-switching, realized in a small packing.

Besides internal synchronization by the standard OCXO, frequency synthesizers of the ND 1000 S series can be synchronized externally in order to access the same reference when operated along with other instruments or to benefit from the stability of an external standard. On the other hand, the frequency synthesizer's high precision OCXO can also synchronize other instruments.

The two differently equipped instrument types ND 1000 S and ND 1000 D are based upon the same technology as the base version ND 1000, used along with various interfaces (BCD, RS 232, IEEE-BUS) they provide optimum match to the specific measuring problem.

Applications of the frequency synthesizers include:

- use in nuclear magnetic resonance spectroscopy, electron spin resonance spectroscopy and microwave spectroscopy.
- transmitting- and receiving section of terrestrial and satellite radio systems.
- fast automatic test systems for antenna-, instrument- and component testing.
- settable frequency reference, derived from frequency standards or used as high precision local oscillator for research and development, etc.

Besides, frequency synthesizers can replace complicated PLL-synthesizers, for which modulation of the carrier is not the key problem, but accuracy, frequency stability and spectral purity are essential.

The Schomandl frequency standard FN-77 and the FN-GPS are particularly suitable for external 10 MHz frequency standards; the FN-77 is based upon the frequency of the long wave transmitter DCF 77 for use in Central Europe whereas the FN-GPS using signals from the GPS-satellite system can be used anywhere in the world.



2 Installation

2.1 Unpacking

Please check the instrument immediately after unpacking for possible transportation damage. When a damage has occurred, please keep packing material, invoice and transportation documents completely since all these items are required to treat that damage. Please inform your nearest dealer immediately. Check the completeness of the delivery by means of the delivery note. In case of any discrepancy, please inform your nearest dealer.



Note:

- for shipping or storing your instrument, please use the original package, if possible. If that is not available, you are advised to use an equivalent package, offering best possible protection for your instrument.
- please always enclose a dehydrating agent to the package in order to protect your instrument from penetrating humidity.
- please observe the storing temperatures as given in the technical specifications.

2.2 Setting up the ND 1000 S

- make sure your instrument gets sufficient ventilation.
- if several instruments are to be operated one atop of another, the frequency synthesizer should be on top.
- in order to avoid heat accumulation, no object should block the ventilator opening and the ventilation holes on the upper and lower surface.



Attention:

Never deposit anything on the instrument.

- in order to avoid damage to the frequency synthesizer and to the instruments connected thereto, all plug-ins and unplugs have to be carried out with AC-power off.



2.3 Mains Voltage

Before switching on the instrument, please check whether the operating voltage the instrument is set to complies with the local mains voltage.

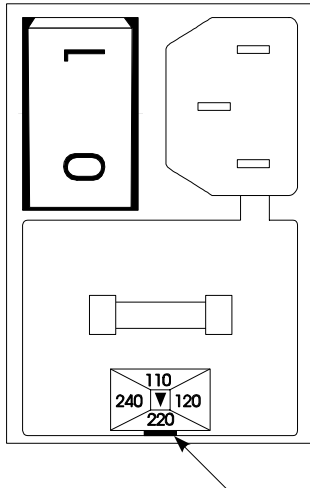

The operating voltage set for the instrument is indicated below the power connection.

An arrow indicates the set voltage.



Attention:

Wrongly set operating voltage may destroy the instrument. Schomandl is not liable for any damage resulting from wrongly set voltage.

2.4 Replacing a Fuse / Adjusting the Mains Voltage

If the local mains voltage does not correspond to the mains voltage the instrument is set to, or if the mains fuse has to be replaced, proceed as follows:

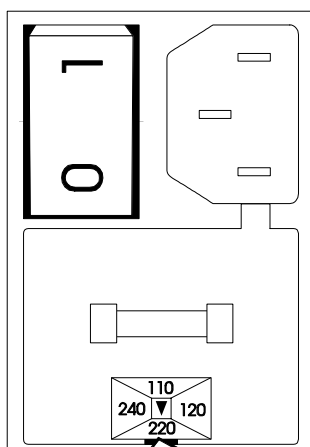

Remove the fuse block from its support by inserting a screwdriver into the prepared recess below the fuse block, use it as a lever and remove the fuse block from its support.





2.4.1 Replacing a Fuse

- Press the bolt of the 'fuse compartment' slightly upwards ① and then pull out the fuse carrier ②.

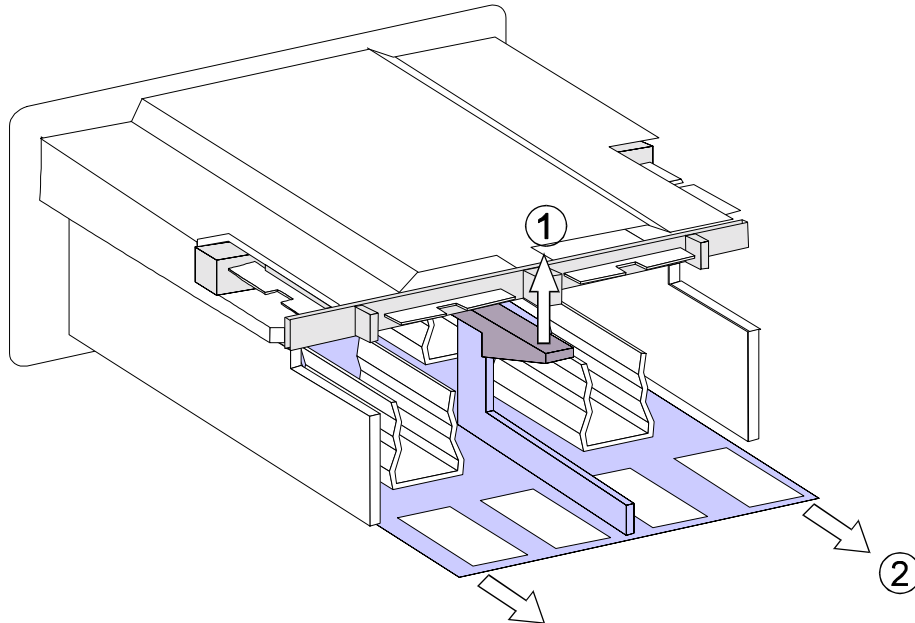

Note:

Only use the following fuse-types:

| | |
|-------------------|----------------|
| For 220...240V AC | Slow-Blow 2,0A |
| For 110...120V AC | Slow-Blow 5,0A |

- After replacing the fuse push back the fuse carrier into its support.

2.4.2 Setting the Mains Voltage

- press the bolt of the 'coding plug' slightly upwards ①, then pull out the coding-plug ②.
- Re-insert the coding plug in such a way, that desired voltage is shown in the front panel window of the fuse carrier.
- Make sure, desired voltage is shown in the fuse-carrier window. (see also 2.3)

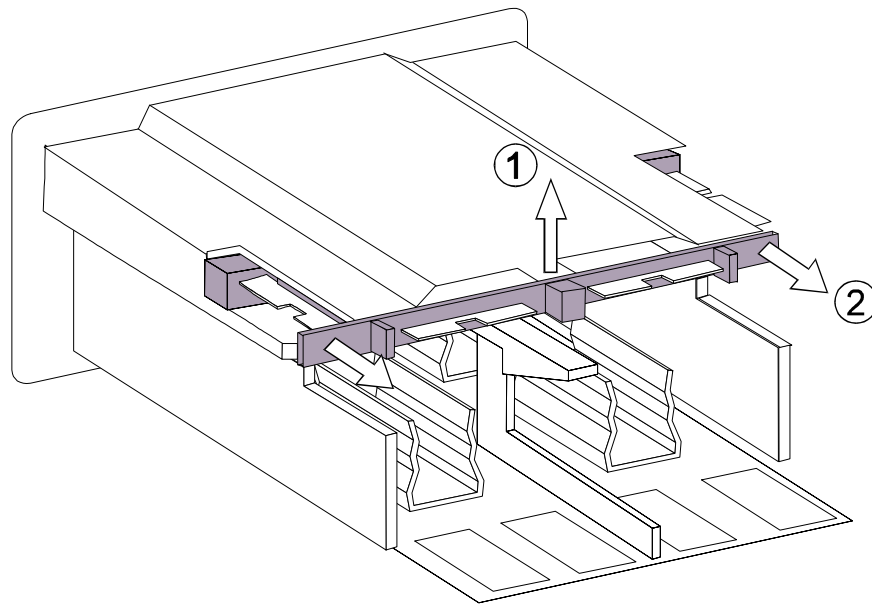

**Note:**

- Frequency Synthesizers of ND 1000 S series are labelled 'CE'.
- Electric fields having field strengths of maximum 10V/m do not degrade performance of the instrument in any way.
- With respect to electrical safety precautions, these frequency synthesizers are tested according to standard VDE 0411, safety class 1.
- Frequency synthesizers of the ND 1000 S series are manufactured according to standard ISO 9001.



3 Construction of the ND 1000 S

3.1 Front Panel

All control knobs are located on the front panel.

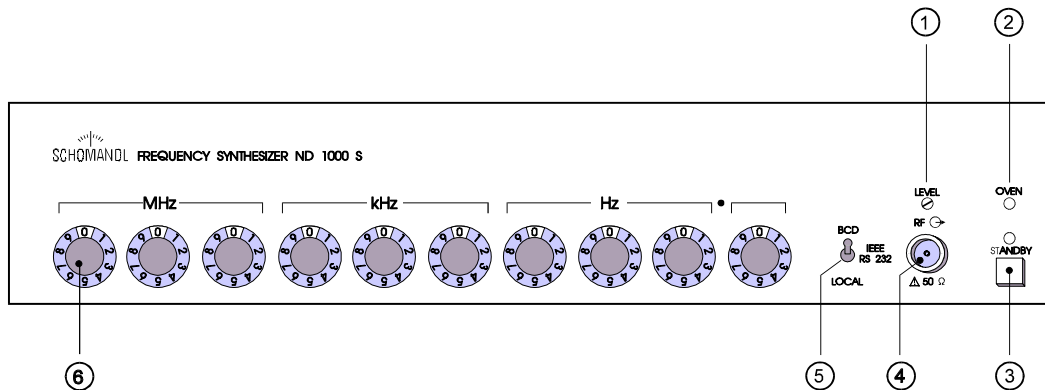

Power level setting

0 ... + 15 dBm setting range (done via slot-screw)

OVEN (LED operation status indicator of the quartz oven heating)

- orange: operating temperature not yet reached.
- green: operating temperature reached.

Standby

- Pushbutton for temporary desactivation of signal generator
- LED lights yellow for STANDBY and green for regular operation mode
- on STANDBY mode only OCXO is running

④ Output socket

- N-connector

⑤ Interface-switch

- Selects modes of operation
 - BCD: Remote control
 - IEEE/RS232: Remote control
 - LOCAL: Control via control knobs on unit



Attention:

Simultaneous operation of IEEE- and RS 232-interface is not allowed!

⑥ Frequency selector

- Setting of desired frequency by 10 switches
- Setting of IEEE listener address



3.2 Rear Panel

On the rear panel of the ND 1000 S the interfaces, frequency reference in- and outputs and the AC power connector are located.

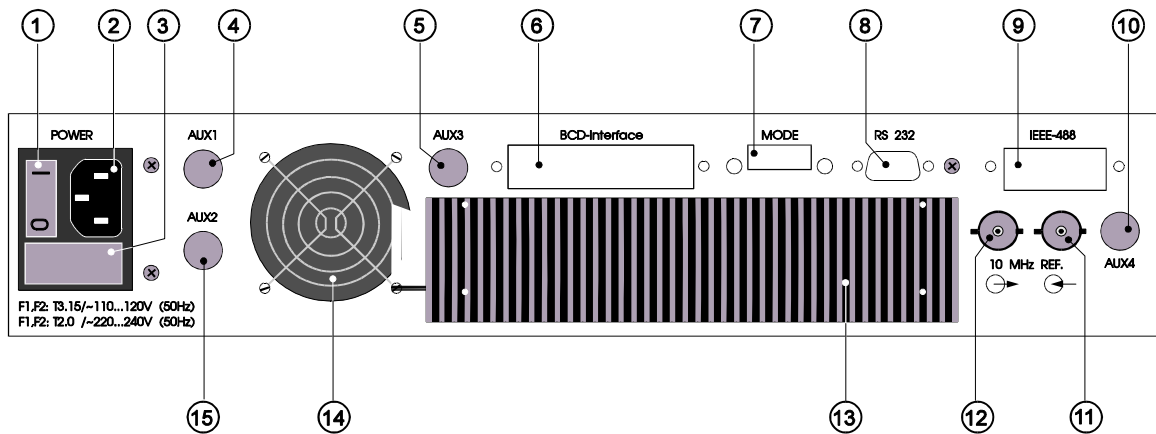

Mains switch (Power ON)

AC power connector

Mains fuses

- ④ **AUX 1** not being used
- ⑤ **AUX 3** not being used
- ⑥ **BCD-parallel-interface**
 - optional parallel interface
- ⑦ **Mode**
 - DIP switch for configuration of BCD parallel-interface
- ⑧ **RS 232 interface**
 - optional serial interface
- ⑨ **IEEE-488 bus**
 - optional IEEE 488 interface
- ⑩ **AUX 4** not being used
- ⑪ **10 MHz reference input**
- ⑫ **10 MHz reference output**
- ⑬ **Heat sink**
- ⑭ **Ventilator**
- ⑮ **AUX 2** not being used



4 Connections of the ND 1000 S

Attention:

Plugging or unplugging may only be done when instrument is switched off. Possibly occurring peak current may destroy unit.

4.1 N-Connector of ND 1000 S

Signal output of the ND 1000 S is via N connector at front panel.

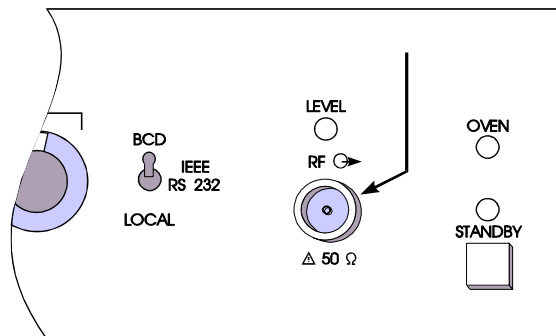

4.2 10 MHz Reference Input

External frequency reference for the ND 1000 S is fed in here.

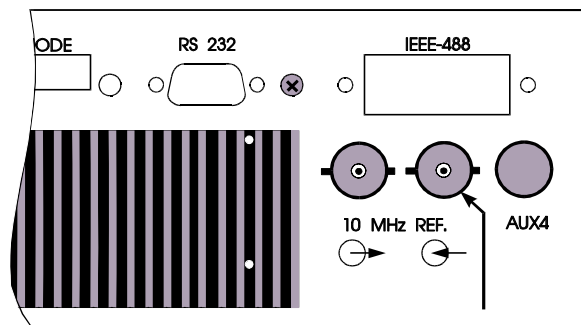

Note:

External frequency reference must fulfil specifications as follows:
 2 MHz, 5 MHz, 10 MHz \pm 2 Hz; 0dBm ... + 8 dBm



4.3 10 MHz Reference Output

This output can be used as frequency reference for other instruments.

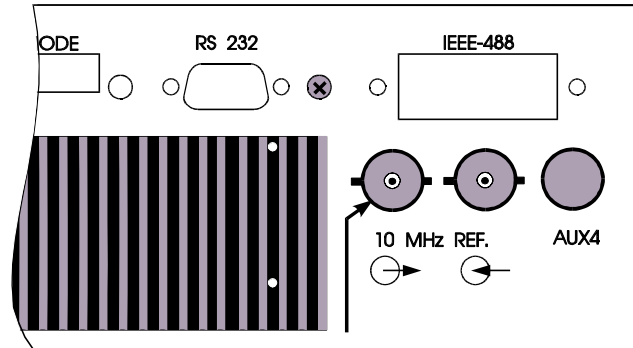

The reference output of the ND 1000 S has following specifications:

| | |
|--------------------------|----------------------------------|
| Frequency: | 10 MHz |
| Temperature coefficient: | $< 3 \cdot 10^{-9}/K$ |
| Aging: | $< 2 \cdot 10^{-8}/\text{month}$ |
| Output level: | + 10 dBm |

 **Attention:**

Pulling of the ND 1000 S's internal reference must be avoided, using external attenuators or buffers for example.



5 Operation of the Frequency Synthesizer ND 1000 S

5.1 Interface switch in position BCD-REMOTE:

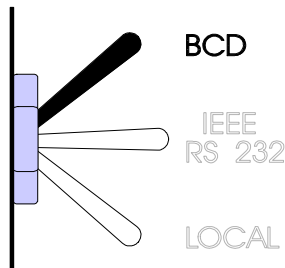

When switch is set to BCD the ND 1000 S is operated via BCD-interface. Manual control is then inhibited (exception: interface-switch).

5.2 Interface switch in position IEEE / RS232:

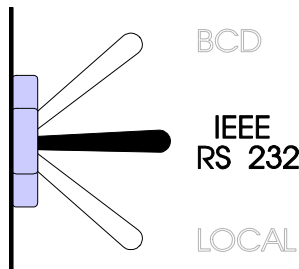

When interface-switch is set horizontally, the IEEE listener address can be set, the RS232-interface is configured.

5.2.1 Setting of IEEE-listener address

The IEEE-listener address is required to interface the frequency synthesizer to other IEEE units via IEEE 488 bus. The interface-switch selects the IEEE-listener address. Proceed as follows:

- Set interface-switch horizontally.
- Switch over to Standby-mode (pushbutton STANDBY), LED atop of pushbutton in on.
- Set desired IEEE-listener address via frequency selector. Use frequency settings shown below:

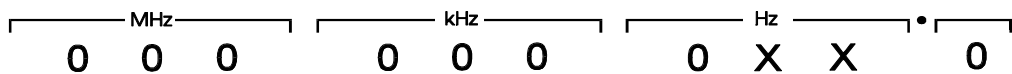

- Useable IEEE-listener address range is between 00 and 30.
- Storing of IEEE-listener address is done automatically when power is turned on (press 'STANDBY'-key).
IEEE-listener address is preset to 10 by manufacturer.



Example:

IEEE-listener address is 19

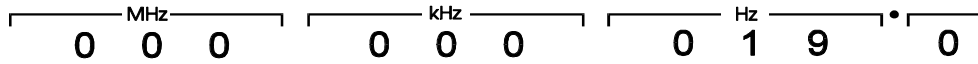

(for further information on IEEE-interface refer to chapter 6.3)

5.2.2 RS 232-Interface

The optionally available RS 232 interface is a 9-pin socket. This interface is used to control the frequency synthesizer via PC software. For further information on RS 232 interface refer to chapter 6.2.

5.3 Setting Frequency and Signal Output Level

The ND 1000 S generates frequencies between 10 000 Hz and 999 999 999,8 Hz in 0,1 Hz < 500 MHz (0,2 Hz \geq 500 MHz) increments.

Output power is settable between 0 and +13 dBm. Below the specified frequency range of 10 kHz, frequencies down to 0 Hz can be entered. However, be aware of the fact, that power levels are not defined then.

5.3.1 Setting Frequency via Rotary Switches

Note:

If rotary switches are used, interface-switch has to be set to 'Local'-mode first.

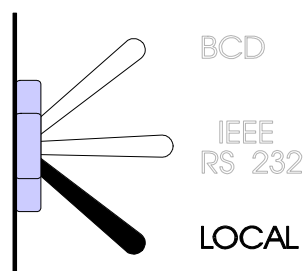

The rotary switches select the desired frequency. The switches have small windows displaying the decadic value.

In order to easy setting and reading frequencies, the first 9 rotary switches are combined in triplets: MHz, kHz, Hz. The last rotary switch selects the first decimal value (0,1 Hz increment).

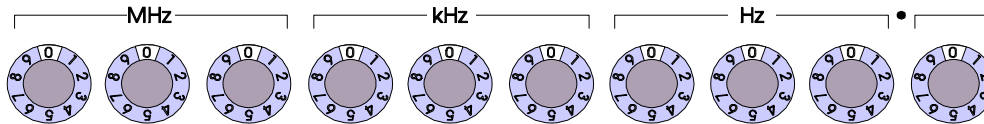

Example:

Suppose you want to enter 120,78 kHz. Proceed as follows:

- If not yet done, set interface-switch to 'LOCAL'.
- Set 'MHz'-triplet to 000
- Set 'kHz'-triplet to 120
- Set 'Hz'-triplet to 780
- Set 0,1 Hz-increment-switch to 0

The windows of the rotary switches will show:

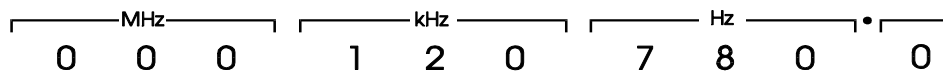

5.3.2 Power level setting

You can select the signal output level by rotating the slot-screw on the front panel.

- rotate counterclockwise to reduce power level (min. < 0 dBm)
- rotate clockwise to increase power level (may. + 15 dBm)



Note:

- Factory setting is +13 dBm \pm 1 dB.
- Power output is specified only for frequency range 10 kHz to 999,999 999 8 MHz.



6 Interfaces

6.1 BCD Interface

The optionally available parallel BCD interface allows extremely fast setting or frequency control by a remote control. The 50-pin BCD interface is being configured by the mode DIP switch.

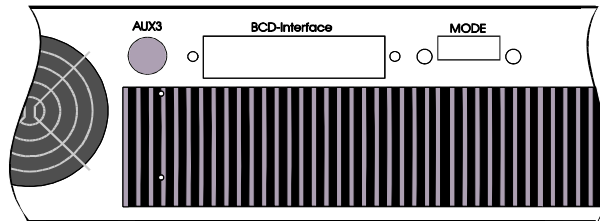

6.1.1 BCD modes

The DIP switches configure the BCD interface.

| Mode | Configuration | DIP - Switch | | | | | |
|------|--|--------------|-----|---|-----|-----|-----|
| | | 6 | 5 | 4 | 3 | 2 | 1 |
| 1 | BCD-parallel mode (positive logic with store) | - | ON | - | ON | ON | ON |
| 2 | BCD-parallel mode (positive logic transparent) | - | ON | - | ON | ON | OFF |
| 3 | BCD-parallel Modus (negative logik transparent) | - | OFF | - | ON | OFF | ON |
| 4 | BCD-parallel Modus (negative logik transparent mit 'Latch Enable' und 'Remote Enable') | - | OFF | - | ON | OFF | OFF |
| 5 | BCD-parallel Modus (double buffering, negative logic with store and 'Remote-Enable') | - | OFF | - | OFF | ON | OFF |

Note:

The DIP-switch 5 activates 10k Ω -Resistors to pull-down (to GND) or to pull up (against +5V) the plug inputs pin 1...21 and pin 23...49 for Dip-switch 5 setting ON or OFF respectively.

Attention:

New interface configurations are initialized only after switching the instrument off and then on again.



6.1.2 Pin Assignment of the BCD Interface mode 1:
positive logic with store

| PIN | Function | PIN | Function |
|-----|----------|-----|------------------------|
| 1 | 100 kHz | 26 | 400 kHz |
| 2 | 200 kHz | 27 | 800 kHz |
| 3 | 10 kHz | 28 | 40 kHz |
| 4 | 20 kHz | 29 | 80 kHz |
| 5 | 1 kHz | 30 | 4 kHz |
| 6 | 2 kHz | 31 | 8 kHz |
| 7 | 100 Hz | 32 | 400 Hz |
| 8 | 200 Hz | 33 | 800 Hz |
| 9 | 10 Hz | 34 | 40 Hz |
| 10 | 20 Hz | 35 | 80 Hz |
| 11 | 1 Hz | 36 | 4 Hz |
| 12 | 2 Hz | 37 | 8 Hz |
| 13 | 0,1 Hz | 38 | 0,4 Hz |
| 14 | 0,2 Hz | 39 | 0,8 Hz |
| 15 | 10 MHz | 40 | 40 MHz |
| 16 | 20 MHz | 41 | 80 MHz |
| 17 | 1 MHz | 42 | D (frequency doubler) |
| 18 | 2 MHz | 43 | 100 MHz |
| 19 | 4 MHz | 44 | 200 MHz |
| 20 | 8 MHz | 45 | nc |
| 21 | nc | 46 | nc |
| 22 | nc | 47 | nc |
| 23 | nc | 48 | take over (pos. slope) |
| 24 | nc | 49 | 400 MHz |
| 25 | nc | 50 | GND |

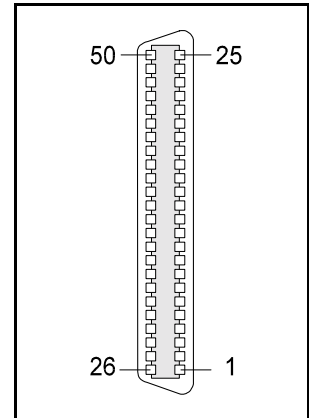

 **Note:**

Storing takes place at positive slope of UALL signal. Rise time must be less than 500ns at TTL-level.



6.1.3 Pin Assignment of the BCD Interface mode 2 and 3
Mode 2 positive logic transparent
Mode 3 negative logic transparent

| PIN | Function | PIN | Function |
|-----|----------|-----|-----------------------|
| 1 | 100 kHz | 26 | 400 kHz |
| 2 | 200 kHz | 27 | 800 kHz |
| 3 | 10 kHz | 28 | 40 kHz |
| 4 | 20 kHz | 29 | 80 kHz |
| 5 | 1 kHz | 30 | 4 kHz |
| 6 | 2 kHz | 31 | 8 kHz |
| 7 | 100 Hz | 32 | 400 Hz |
| 8 | 200 Hz | 33 | 800 Hz |
| 9 | 10 Hz | 34 | 40 Hz |
| 10 | 20 Hz | 35 | 80 Hz |
| 11 | 1 Hz | 36 | 4 Hz |
| 12 | 2 Hz | 37 | 8 Hz |
| 13 | 0,1 Hz | 38 | 0,4 Hz |
| 14 | 0,2 Hz | 39 | 0,8 Hz |
| 15 | 10 MHz | 40 | 40 MHz |
| 16 | 20 MHz | 41 | 80 MHz |
| 17 | 1 MHz | 42 | D (frequency doubler) |
| 18 | 2 MHz | 43 | 100 MHz |
| 19 | 4 MHz | 44 | 200 MHz |
| 20 | 8 MHz | 45 | nc |
| 21 | nc | 46 | nc |
| 22 | nc | 47 | nc |
| 23 | nc | 48 | nc |
| 24 | nc | 49 | 400 MHz |
| 25 | nc | 50 | GND |

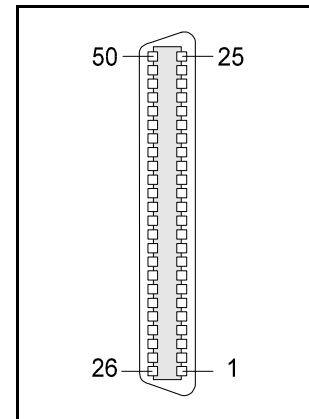

6.1.4 Pin Assignment of the BCD Interface mode 4 latch enable and remote enable

| PIN | Function | PIN | Function |
|-----|---------------------|-----|-------------------|
| 1 | 100 kHz | 26 | 400 kHz |
| 2 | 200 kHz | 27 | 800 kHz |
| 3 | 10 kHz | 28 | 40 kHz |
| 4 | 20 kHz | 29 | 80 kHz |
| 5 | 1 kHz | 30 | 4 kHz |
| 6 | 2 kHz | 31 | 8 kHz |
| 7 | 100 Hz | 32 | 400 Hz |
| 8 | 200 Hz | 33 | 800 Hz |
| 9 | 10 Hz | 34 | 40 Hz |
| 10 | 20 Hz | 35 | 80 Hz |
| 11 | 1 Hz | 36 | 4 Hz |
| 12 | 2 Hz | 37 | 8 Hz |
| 13 | 0,1 Hz | 38 | 0,4 Hz |
| 14 | 0,2 Hz | 39 | 0,8 Hz |
| 15 | 10 MHz | 40 | 40 MHz |
| 16 | 20 MHz | 41 | 80 MHz |
| 17 | 1 MHz | 42 | REM |
| 18 | 2 MHz | 43 | 100 MHz |
| 19 | 4 MHz | 44 | 200 MHz |
| 20 | 8 MHz | 45 | 800 MHz |
| 21 | nc | 46 | LE 10 Hz - 800 Hz |
| 22 | nc | 47 | LE 0,1 Hz - 8 Hz |
| 23 | LE 10 MHz - 800 MHz | 48 | nc |
| 24 | LE 100 kHz - 8 MHz | 49 | 400 MHz |
| 25 | LE 1 kHz - 80 kHz | 50 | GND |

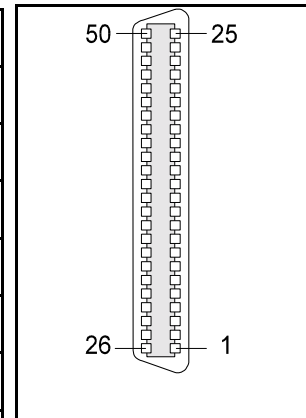

**Note:**

- **GND:** Ground
- **LE: High:** The data enters the latches, the latches are transparent.
Low: The latches store the information that was present on the data inputs during the HIGH-to-LOW transition of LE.
- **REM: High:** Remote Control is disabled. The data enters the input-latches, but the output frequency is set to 0 Hz (no output signal).
Low: Remote Control is enabled.

**Attention:**

The REM-Pin does not override the Local/Remote-switch at the front panel of the ND1000S. That means, that you must set the ND 1000S to 'Local' mode, if the frequency control via front panel is used and you must set the ND 1000S to 'Remote' mode, if the remote frequency control is used.

PIN 45 has to be set to HIGH-level using either the DIP-switch (DIP 5 =OFF) or an external voltage (+5V).



6.1.5 Pin Assignment of the BCD Interface mode 5
 double buffering, negative logic with store and remote enable

| PIN | Function | PIN | Function |
|-----|-----------------------|-----|---------------------|
| 1 | 100 kHz | 26 | 400 kHz |
| 2 | 200 kHz | 27 | 800 kHz |
| 3 | 10 kHz | 28 | 40 kHz |
| 4 | 20 kHz | 29 | 80 kHz |
| 5 | 1 kHz | 30 | 4 kHz |
| 6 | 2 kHz | 31 | 8 kHz |
| 7 | 100 Hz | 32 | 400 Hz |
| 8 | 200 Hz | 33 | 800 Hz |
| 9 | 10 Hz | 34 | 40 Hz |
| 10 | 20 Hz | 35 | 80 Hz |
| 11 | 1 Hz | 36 | 4 Hz |
| 12 | 2 Hz | 37 | 8 Hz |
| 13 | 0,1 Hz | 38 | 0,4 Hz |
| 14 | 0,2 Hz | 39 | 0,8 Hz |
| 15 | 10 MHz | 40 | 40 MHz |
| 16 | 20 MHz | 41 | 80 MHz |
| 17 | 1 MHz | 42 | REM |
| 18 | 2 MHz | 43 | STROBE |
| 19 | 4 MHz | 44 | 800 MHz |
| 20 | 8 MHz | 45 | 400 MHz |
| 21 | nc | 46 | RSTR 10 Hz - 800 Hz |
| 22 | nc | 47 | RSTR 0,1 Hz - 8 Hz |
| 23 | RSTR 10 MHz - 800 MHz | 48 | 200 MHz |
| 24 | RSTR 100 kHz - 8 MHz | 49 | 100 MHz |
| 25 | RSTR 1 kHz - 80 kHz | 50 | GND |

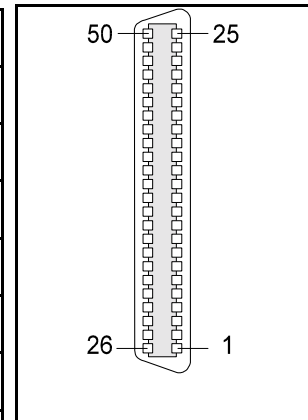

**Note:**

- **GND:** Ground
- **RSTR:** A LOW-to-HIGH transition of the register strobe input will store the data into the first rank of buffers.
- **REM: High:** Remote Control is disabled.
The data enters the input-latches, but the output frequency is set to 0 Hz (no output signal).
Low: Remote Control is enabled.
- **STROBE:** A LOW-to-HIGH transition of the strobe no sooner than 100ns after the LOW-to-HIGH transition of the RSTR lines will clock the data into the second rank of buffers to start the change of frequency.

**Attention:**

The REM pin does not override the Local/Remote-switch at the front panel of the ND1000S respectively. That means, that you must set the synthesizer to 'Local' mode, if the frequency control via front panel is used and you must set the synthesizer to 'Remote' mode, if the remote frequency control is used.

Changes of state of REM pin and of STROBE pin must differ 200ns minimum.

PIN 44 has to be set to HIGH-level using either the DIP-switch (DIP 5 =OFF) or an external voltage (+5V).



6.2 RS 232 Interface

The optionally available serial RS 232 interface is a standard 9-pin connector. This interface is used to control the frequency synthesizer via PC software.

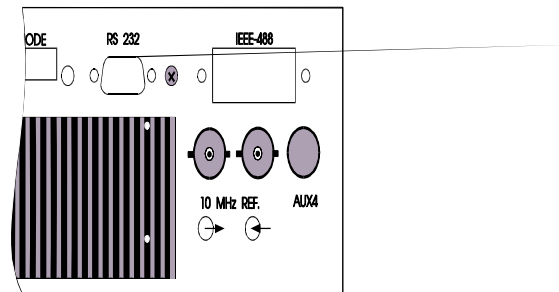

6.2.1 Definition of the RS 232 interface

| | | |
|-----|---|-------------------------------|
| DCD | = | data transmission identified |
| RX | = | data receiver |
| TX | = | data transmitter |
| DTR | = | data terminal ready |
| DSR | = | Data set ready |
| RTS | = | Ready to send |
| CTS | = | standby for data transmission |
| RI | = | identification |

6.2.2 Pin Configuration of the RS 232 Interface

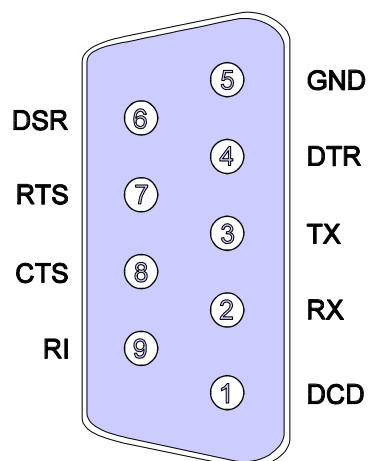

6.2.3 Connecting the ND 1000 S to Personal Computer

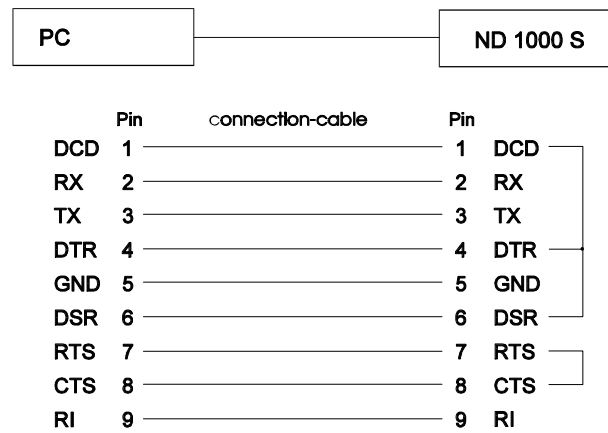

6.2.4 Programming of the RS 232 Interface



Attention:

Simultaneous operation of IEEE- and RS 232-interface is not allowed!

6.2.4.1 Composition of a data block

The RS 232 interface is operated in following mode:

| | |
|------------|------------|
| Baudrate: | 4.8 k Baud |
| start bit | 1 bit |
| data bits | 8 bits |
| stop bit | 1 bit |
| parity bit | no bit |

Every valid RS 232 instruction from the PC is followed by an echo from the ND 1000 S containing the new setting.

In case of invalid RS 232 instruction, no new setting is transmitted; the message '\$ERROR CR+LF' is transmitted to PC.



6.2.4.2 Structure of RS 232 command PC → ND 1000 S

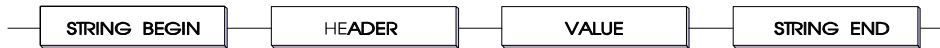

6.2.4.3 Structure of RS 232 message (echo) ND 1000 S → PC

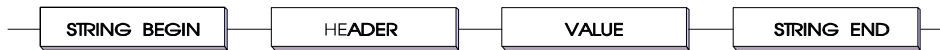

- **String Begin:** consists of the \$-sign
- **Header:** The header is the actual instruction and always consists of 4 characters.
- **Value:** value assigned to instruction. The number of characters depends on the instruction.
- **String End:** has to follow the last character of the value and consists of CR and LF (13+10)

6.2.5 Local / Remote mode of the ND 1000 S

If the frequency synthesizer ND 1000 S is operated as listener, its state switches over to REMOTE. Manual entry keys are then inhibited.

You can return to manual operation in two ways:

- by means of the addressed instruction **gtlc** (Go to Local).
 - The value of the rotary switches is taken over.
- by means of the interface-switch to LOCAL.
 - The value of the rotary switches is taken over.

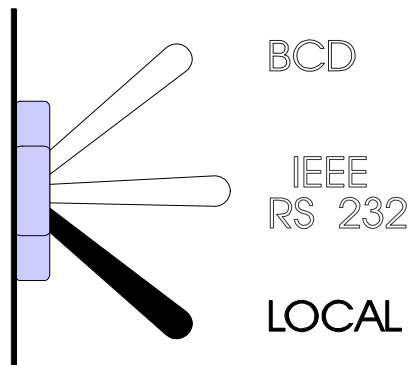

6.2.6 Instrument message for ND 1000 S

Following instructions are required to control the frequency synthesizer ND 1000 S:

| Start | Header | Value | End | Unit | Description |
|-------|--------|------------|-------|-------|------------------|
| \$ | frq_ | xxx.xxxxxx | CR+LF | [MHz] | set RF-frequency |
| \$ | gtlc | | CR+LF | | |



Note:

- The Header always consists of 4 characters, meaning that frq always must be programmed followed by a (_).
- Setting range for RF-frequencies: 0.0000001 ... 999.9999998 MHz
- Setting of appropriate units is not required, since always MHz being used.



Example:

```
Programming 10.1234567 MHz:  $frq__10.1234567CRLF
Programming 100.1234567 MHz: $frq_100.1234567CRLF
```



6.3 IEEE 488 Interface

The optional IEEE 488 interface complies with standard IEC 625 and IEEE 488. It enables various measurement instruments and computers to exchange data via the data bus. All connected instruments are parallel to this bus and access all data lines.

The instruments connected to the IEEE bus can, according to their function, send or receive messages (Talker and Listener respectively).

The instruments connected to an IEEE bus system are distinguished as follows:

- **Listener:** can only receive data
- **Talker:** can only transmit data
- **Talker/Listener:** can as well receive and transmit data
- **Controller:** controls the functions and exchange of information between the instruments. (i.e. computers)

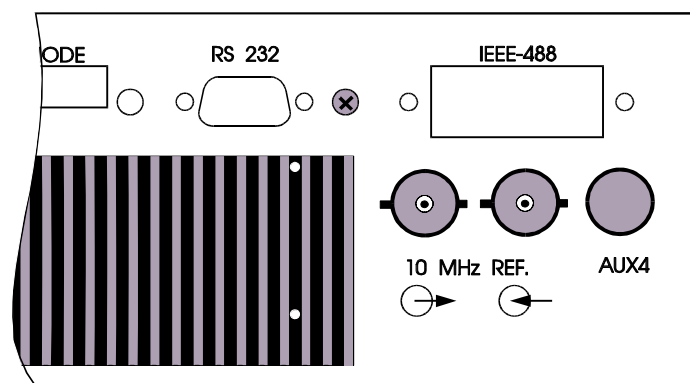

Note:

The ND 1000 S are operated in Listener mode.

Data transfer between the individual connected instruments is done serial by byte. In order to make instruments with different execution speed operate on the bus, data exchange is done in connection with a three-step handshake process.

The bus employs negative logic and can be operated with a maximum cable length of 20 meters.

Attention:

Simultaneous operation of IEEE- and RS 232-interface is not allowed!



6.3.1 Description of the IEEE 488 Interface

The IEEE 488 connection socket is located at the rear panel of the frequency synthesizer. The interface contains 16 bus lines which can be combined in 3 groups (data bus, control bus, handshake bus).

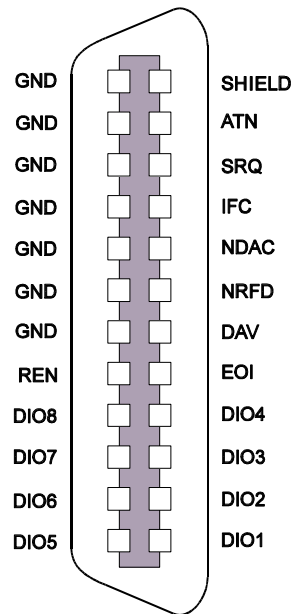

6.3.1.1 Data Bus

The data bus consists of 8 lines

- DIO 1... DIO 8
- LSB = DIO 1

6.3.1.2 Control Bus

The control bus consists of 5 lines

- **ATN (Attention):** ATN is activated when addresses, universal and addressed instructions are being sent.
- **REN (Remote Enable):** Switches on or off the remote control of the instrument.
- **SRQ (Service Request):** The instrument sends an operation call to the controller.
- **IFC (Interface Clear):** This signal is activated by the controller to preset the instruments connected to IEEE bus to a defined state. ATN signal the controller calls for parallel scan.
- **EOI (End or Identify):** The last byte of a data transfer is transmitted. In conjunction with ATN, the controller requests for a parallel search.



6.3.1.3 Handshake Bus

The handshake bus consists of 3 lines:

- **DAV (Data valid):** The DAV signal is activated whenever new valid data are available on the bus.
- **NRFD (Not ready for Data):** signalizes to the talker, that data cannot yet be accepted (active at logic LOW)
- **NDAC (Not Data Accepted):** One of the listeners has not yet accepted offered data.

6.3.2 Structure of the IEEE 488 interface

The IEEE 488 interface is according to IEEE standard 488-1978 and contains the following equipment:

| | | |
|------|----------------------------------|-----|
| SH1: | Talker's Handshake | NO |
| AH1: | Listener's Handshake | YES |
| L4: | no listen only | YES |
| | unlisten by addressing as talker | YES |
| T8: | Serial Poll | NO |
| | Talker only | NO |
| SRO: | Service Request | NO |
| PPO: | Parallel Poll | NO |
| RL2: | Local lock out | NO |
| DC1: | Device clear | YES |
| | Select driver clear | YES |
| DTO: | Device Trigger | NO |

6.3.3 Local / Remote mode of the ND 1000 S

If the frequency synthesizer ND 1000 S is operated as listener, its state switches over to REMOTE. Manual entry keys are then inhibited.

You can return to manual operation in two ways:

- by means of the addressed instruction **GTL** (Go to Local).
 - The value of the rotary switches is taken over.
- by means of the interface-switch to **LOCAL**.
 - The value of the rotary switches is taken over.

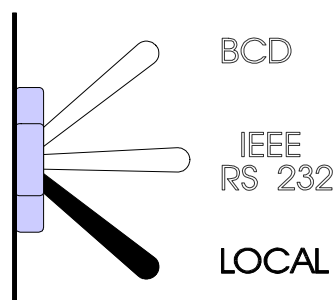

6.3.4 Setting of the IEEE-listener address on the ND 1000 S

The BCD/LOCAL-switch selects the IEEE-listener address. Proceed as follows:

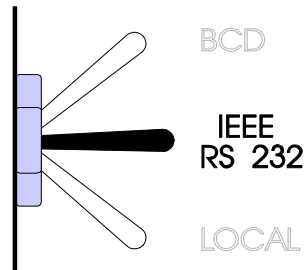

- Set BCD/LOCAL-switch horizontally.
- Switch over to Standby (pushbutton STANDBY), LED atop of pushbutton is 'on' in standby-mode.
- Set desired IEEE-address via frequency selector switches.
Use the frequency setting shown below:

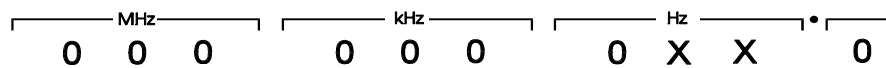

- Useable IEEE-address range is between 00 and 30.
- Storage of the IEEE-listener address is done automatically when power is turned on (press 'STANDBY'-key).
IEEE-listener address is preset to 10 by manufacturer.



Example:

IEEE-listener address is 19. Proceed as follows:

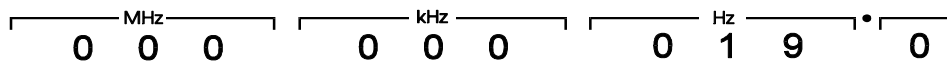

6.3.5 Interface Messages

Interface messages are transferred to the data lines of the ND 1000 S when ATN (Attention) is active. They are used to control the instruments connected to the IEEE bus; that means, these instruments are set to an instrument-specific state. These data can be classified in two different groups:

- universal instructions
- addressed instructions



6.3.5.1 Universal Instructions

Universal instructions are valid for all connected IEEE bus users. For the ND 1000 S only the instruction DCL is relevant.

- **DCL (Device Clear)** Resets the ND 1000 S into its original state. Thus, it has the same effect as switching on the instrument again.

6.3.5.2 Addressed Instructions

Addressed instructions are effective only on IEEE-bus users which are addressed as listeners. For the ND 1000 S only two instructions are relevant.

- **SDC (Select Device Clear)** Resets the ND 1000 S in its original state. Thus, it has the same effect as switching on the instrument again.
- **GTL (Go to Local)** Switches the ND 1000 S to manual operation.

Please refer to following IEC-character-set table to see the IEEE instructions:

| controlcode | | | | | digits and special characters | | | | capital letters | | | | small letters | | | | |
|------------------------|-----|-----|------------------------|-----|-------------------------------|------------------|----|----|-----------------|----------------|---|----|---------------|--------------------------------------|---|-----|-----|
| 0 | NUL | | 16 | DLE | | 32 | SP | 48 | 0 | 64 | @ | 80 | P | 96 | ' | 112 | p |
| 1 | SOH | GTL | 17 | CD1 | | 33 | ! | 49 | 1 | 65 | A | 81 | Q | 97 | a | 113 | q |
| 2 | STX | | 18 | DC2 | | 34 | " | 50 | 2 | 66 | B | 82 | R | 98 | b | 114 | r |
| 3 | ETX | | 19 | DC3 | | 35 | # | 51 | 3 | 67 | C | 83 | S | 99 | c | 115 | s |
| 4 | EOT | SDC | 20 | DC4 | DLC | 36 | \$ | 52 | 4 | 68 | D | 84 | T | 100 | d | 116 | t |
| 5 | ENQ | PPC | 21 | NAK | PPU | 37 | % | 53 | 5 | 69 | E | 85 | U | 101 | e | 117 | u |
| 6 | ACK | | 22 | SYN | | 38 | & | 54 | 6 | 70 | F | 86 | V | 102 | f | 118 | v |
| 7 | BEL | | 23 | ETB | | 39 | ' | 55 | 7 | 71 | G | 87 | W | 103 | g | 119 | w |
| 8 | BS | GET | 24 | CAN | SPE | 40 | (| 56 | 8 | 72 | H | 88 | X | 104 | h | 120 | x |
| 9 | HT | TCT | 25 | EM | SPD | 41 |) | 57 | 9 | 73 | I | 89 | Y | 105 | i | 121 | y |
| 10 | LF | | 26 | SUB | | 42 | * | 58 | : | 74 | J | 90 | Z | 106 | j | 122 | z |
| 11 | VT | | 27 | ESC | | 43 | + | 59 | ; | 75 | K | 91 | [| 107 | k | 123 | { |
| 12 | FF | | 28 | FS | | 44 | , | 60 | < | 76 | L | 92 | \ | 108 | l | 124 | |
| 13 | CR | | 29 | GS | | 45 | - | 61 | = | 77 | M | 93 |] | 109 | m | 125 | } |
| 14 | SO | | 30 | RS | | 46 | . | 62 | > | 78 | N | 94 | ^ | 110 | n | 126 | ~ |
| 15 | SI | | 31 | US | | 47 | / | 63 | UNL | 79 | O | 95 | _ | 111 | o | 127 | DEL |
| addressed instructions | | | universal instructions | | | listener address | | | | memory address | | | | sekundary addresses and-instructions | | | |



6.3.6 Instrument Messages

In contrast to the interface messages, instrument messages are actually those instructions transferring data to the IEEE bus users. Instrument messages are transferred to the data lines of the ND 1000 S when ATN (Attention) is **not active**. For these messages, the ISO-7-Bit ASCII Code is used.

6.3.6.1 Structure of an instrument message

The messages which can be received in listener-mode are composed of the following items:



- **Header:** The header corresponds to the instruction and always consists of 4 characters.
- **Value:** the value corresponding to the header used. Number of characters depends on the instruction.
- **EOI (End or Identify):** The last byte of a data transfer is transmitted.

6.3.6.2 Instrument messages for the ND 1000 S

Operation of the ND 1000 S requires one instruction.

| Header | Value | Unit | Description |
|--------|-------------|-------|------------------|
| frq_ | xxx.xxxxxxx | [MHz] | set RF-frequency |



Note:

- The header always consists of 4 characters; frq always have to be programmed with a following (_).
- Setting range for frequencies: 0.0000001 ... 999.9999998 MHz
- Units must not be entered since MHz is always used.



Examples:

Programming 10.1234567 MHz: frq_10.1234567
 Programming 100.1234567 MHz: frq_100.1234567



7 Appendix

7.1 Technical Specifications ND 1000 S

Reference Frequency:

| | |
|---|-------------------------------------|
| Frequency: | 10 MHz |
| Temperature coefficient: | $< 3 \times 10^{-9}/K$ |
| Temperature influence: (+5°C ... +45°C) | $< \pm 1.5 \times 10^{-8}$ |
| Ageing: | $< 2 \times 10^{-8}/\text{month}$ |
| Warm-up-time: | 15 minutes at 25°C |
| Reference output level: | +10 dBm |
| Reference input level: | 2 MHz, 5 MHz, 10 MHz ; 0dBm...+8dBm |
| Injection-lock range: | $\leq 2 \times 10^{-7}$ |
| Connector: | BNC |

Carrier Frequency:

| | |
|--|---|
| Frequency range: | 10 kHz..999.999 999 8 MHz |
| Resolution: | 0.1 Hz (for $f < 500$ MHz) 0.2 Hz (for $f \geq 500$ MHz) |
| Frequency accuracy: | as reference |
| Frequency setting: | switch (option) BCD parallel (option RS 232) (option IEEE bus) |
| Settling time for new frequency (< 1MHz step width) | $< 1 \mu\text{s}$ |
| Settling time for new frequency (≥ 1 MHz step width) | $< 20 \mu\text{s}$ |
| Phase stability (<1 MHz step width): | continuous |

Spectral purity:

| | |
|--|---|
| Harmonics (levels $\leq +13$ dBm): | < -30 dBc |
| Spurious (discrete): | ($f < 500$ MHz): < -72 dBc ($f \geq 500$ MHz): < -65 dBc |
| Sub-harmonics: | ($f < 500$ MHz): none ($f \geq 500$ MHz): < -65 dBc |
| Residual FM (CCITT, RMS): | < 0.1 Hz |
| SSB-noise (10 kHz offset from carrier) | ($f < 500$ MHz): < -126 dBc/Hz ($f \geq 500$ MHz): < -120 dBc/Hz |
| Noise floor (level: +13 dBm) | ($f < 500$ MHz): < -138 dBc/Hz ($f \geq 500$ MHz): < -135 dBc/Hz |

Output:

| | |
|-----------------------------------|----------------------|
| Output level: | +13 dBm ± 1.5 dB |
| Level setting range: (overrange*) | < 0 dBm...+15 dBm |
| Impedance: | 50 Ω |
| VSWR: | < 1.8 |
| Connector: | N-Type |

* These specifications are related to a level setting of + 13 dBm.



General Features

| | |
|-------------------------------------|--------------------------------|
| Power supply: | 110/120/220/240V ± 10% |
| Power consumption, frequency: | 47..63 Hz, 95 VA, 9VA stand-by |
| Electric security:..... | VDE 0411, Protective Class 1 |
| EMC:..... | CE-mark |
| Maximum field strength:..... | > 10V/m |
| Manufacturing standard:..... | according to ISO 9001 |
| Operating temperature: | +5°C...+45°C |
| Storage temperature:..... | -10°C...+60°C |
| Dimensions (W x H x D): | 450 mm x 100 mm x 450 mm |
| Weight: | approx. 13 kg |

Accessories supplied:

| | |
|---------------|---------------------------------|
| 1 piece | power cord |
| 1 piece | operating manual German/English |
| 1 set..... | spare fuses |

7.2 Service: Reference frequency calibration

With respect to the xtal's aging, an annual control/correction is recommend. An adequate reference source, e.g. Schomandl FN77 or FN-GPS, and an oszilloscope to represent the Lissajous's figure, are required for comparison.

In order to do this, check for a plug on bottom-side, nearby the reference-output.

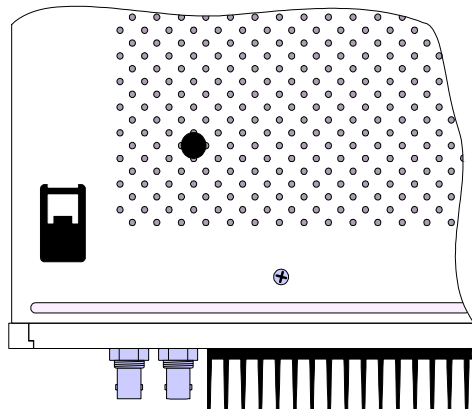

Open the plug and calibrate with an ironless screwdriver (plastic) e.g. Bernstein 1-306.

⚠ Attention:

This calibration requires an authorized technician.

7.3 Ordering Specifications ND 1000 Series

| | |
|---------------------------------------|--------------|
| Frequency Synthesizer ND 1000 S | BN 86306.000 |
| Option IEEE-Bus | BN 86302.102 |
| Option RS 232 | BN 86302.103 |
| Option BCD-Interface | BN 86302.104 |



Option 19"-adapter BN 86302.101

